

REVISION HISTORY			
REV	DESCRIPTION	DATE	APPROVED
D	DCN 59684	05/26	SEE PDM

# PRODUCT DATA DRAWING

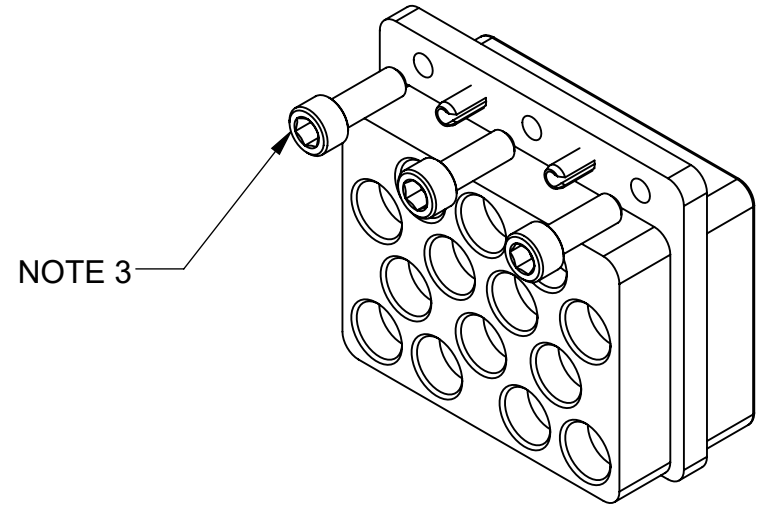

NOTE 3

HOLE CHART		
HOLE No.	X	Y
ORIGIN	0.000	0.000
A1	0.423	0.217
A2	0.200	0.217
A3	-0.023	0.217
B1	0.584	0.365
B2	0.315	0.408
B3	0.085	0.408
B4	-0.184	0.365
C1	0.476	0.557
C2	0.200	0.600
C3	-0.076	0.557
D1	0.584	0.749
D2	0.362	0.749
D3	0.038	0.749
D4	-0.184	0.749

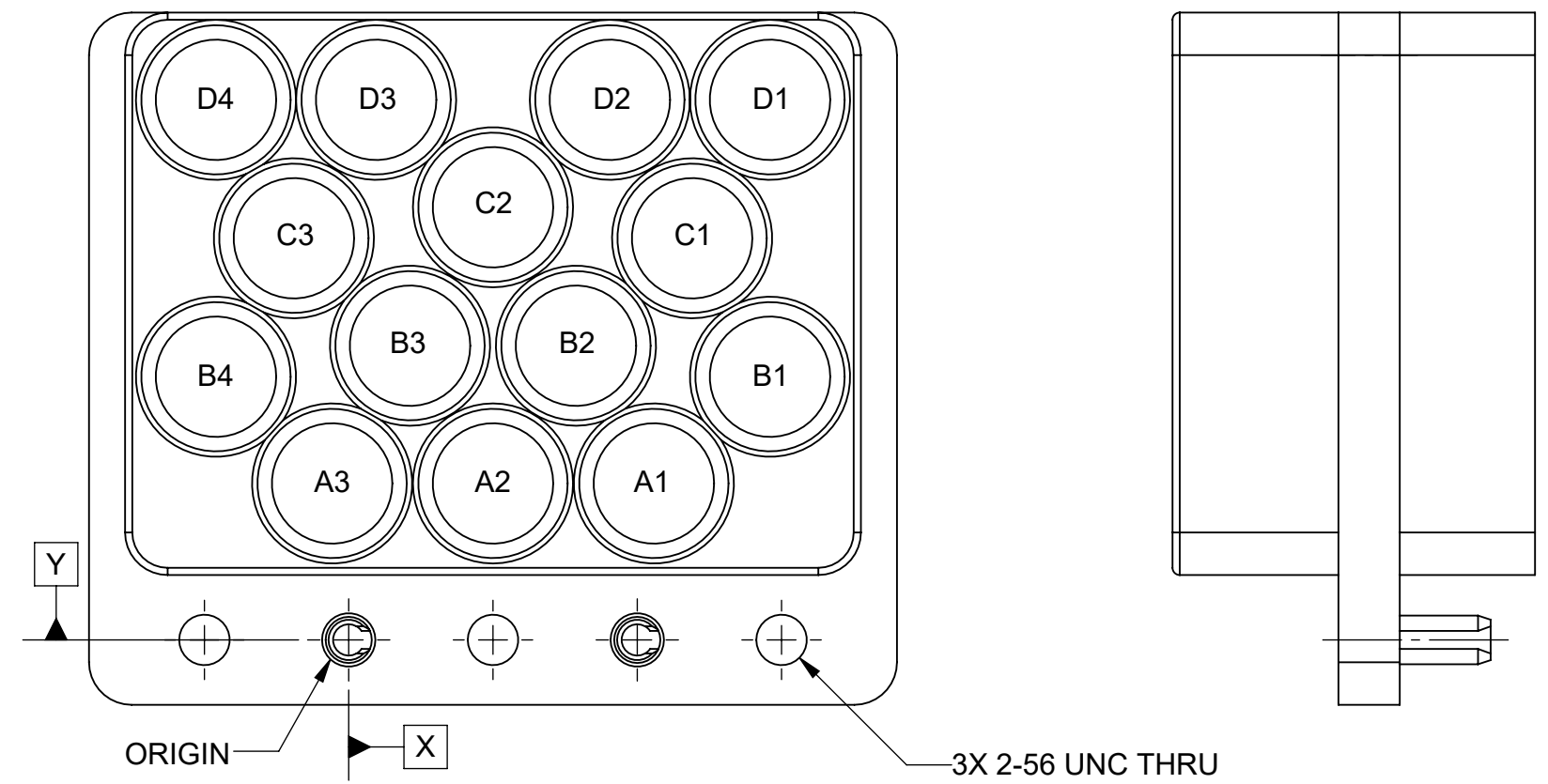

**MATERIAL:**

**BODY:** STAINLESS STEEL PER AMS-5640, ALLOY UNS S30300, TYPE 1; OR ASTM A582 TYPE 303, COND. A

**ALIGNMENT PINS:** STAINLESS STEEL PER ASTM A313, ALLOY UNS S30200, TYPE 302

**SCREWS:** 18-8 STAINLESS STEEL

**FINISH:**

**BODY & ALIGNMENT PINS:** PASSIVATED PER AMS-2700

**SCREWS:** PASSIVATED

- NOTES:**
1. USES 3221-40066 CONTACT OR SIMILAR.
  2. MATES TO SF9301-60042 OR SF9311-60147 PLUG-IN MODULE.
  3. DATE CODES 2623 AND LATER INCLUDE THREE SETS OF MOUNTING SCREWS, COVERING PCB THICKNESSES OF .063"-.102", .097"-.133", AND 160"-.196".

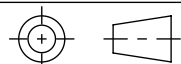
MATERIAL: SEE NOTES	DIMENSIONS ARE IN INCHES TOLERANCES: FRACTIONAL: $\pm 1/64$ ANGULAR: X° $\pm 1'0"$ X°X' $\pm 15'$	UNLESS OTHERWISE SPECIFIED	 www.svmicrowave.com
FINISH: SEE NOTES	DECIMAL: X $\pm .030$ .XX $\pm .010$ .XXX $\pm .005$	1) ALL DIMENSIONS ARE IN INCHES (MILLIMETERS) 2) ALL DIMENSIONS ARE AFTER PLATING. 3) BREAK CORNERS & EDGES .005 R. MAX. 4) CHAM. 1ST & LAST THREADS. 5) SURFACE ROUGHNESS 63-MIL-STD-10. 6) DIA: 'S ON COMMON CENTERS TO BE CONCENTRIC WITHIN .005 T.I.R. 7) REMOVE ALL BURRS	
SURFACE AREA: N/A	INTERPRET DIMENSIONS AND TOLERANCES PER ASME Y14.5M - 1994	THIRD ANGLE PROJECTION	TITLE: VITA 67.3 BACKPLANE MODULE C 14 PORT, SMPM
<b>PROPRIETARY</b> THE INFORMATION CONTAINED IN THIS DRAWING IS THE SOLE PROPERTY OF SV MICROWAVE, INC. ANY REPRODUCTION IN PART OR AS A WHOLE WITHOUT THE WRITTEN PERMISSION OF SV MICROWAVE, INC IS PROHIBITED.		DRAWN: JDT 04/05/18 CHECKED: SEE PDM APPROVED: SEE PDM	SIZE DWG. NO. SF9321-60086 SCALE: 4:1 SHEET 1 OF 2

# PRODUCT DATA DRAWING

REVISION HISTORY			
REV	DESCRIPTION	DATE	APPROVED
	SEE SHEET 1		

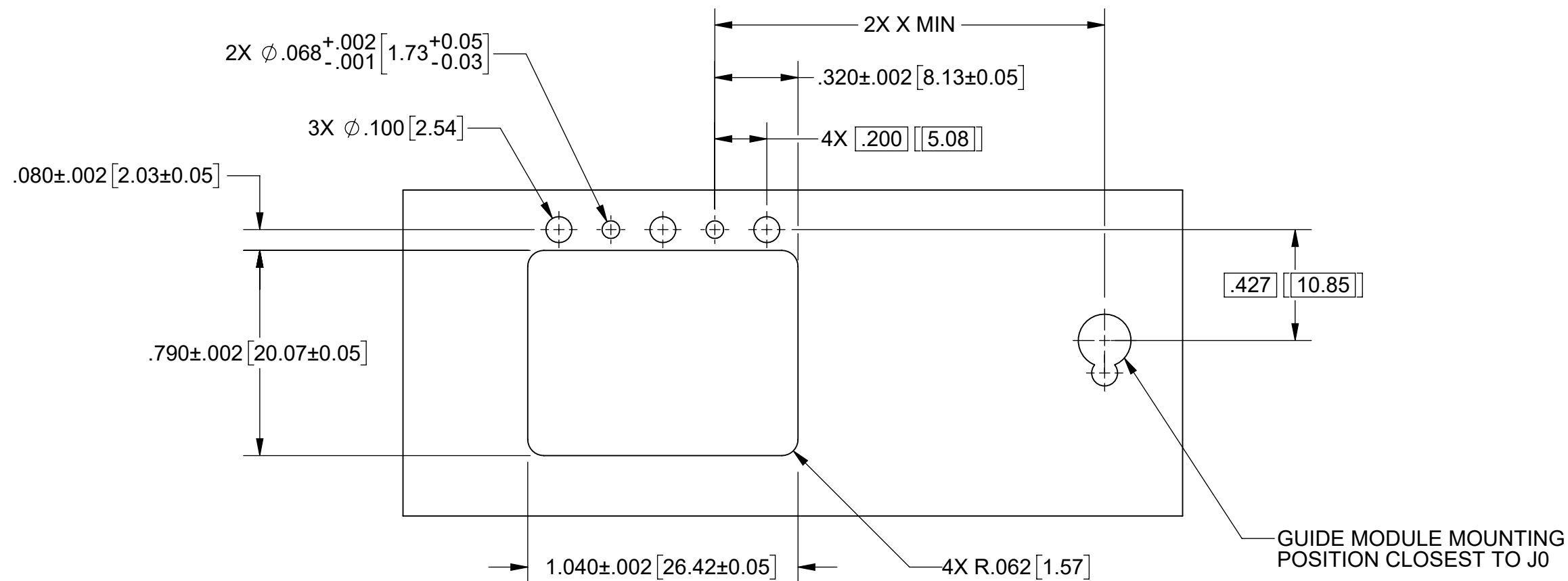

## RECOMMENDED PCB CUTOUT

CONNECTOR LOCATION ON BACKPLANE PCB	
POSITION	DIM 'X'
J2	2.385" [60.58]
J3	3.942" [100.13]
J4	5.276" [134.00]
J5	6.409" [162.80]
J6	7.557" [191.95]

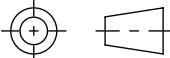
MATERIAL: SEE NOTES	DIMENSIONS ARE IN INCHES TOLERANCES: FRACTIONAL: $\pm 1/64$ ANGULAR: X° $\pm 1'0"$ X°X' $\pm 15'$	UNLESS OTHERWISE SPECIFIED 1) ALL DIMENSIONS ARE IN INCHES (MILLIMETERS) 2) ALL DIMENSIONS ARE AFTER PLATING. 3) BREAK CORNERS & EDGES .005 R. MAX. 4) CHAM. 1ST & LAST THREADS. 5) SURFACE ROUGHNESS 63-MIL-STD-10. 6) DIA: 'S ON COMMON CENTERS TO BE CONCENTRIC WITHIN .004 T.I.R. 7) REMOVE ALL BURRS	 Amphenol www.svmicrowave.com TITLE: VITA 67.3 BACKPLANE MODULE C 14 PORT, SMPM
FINISH: SEE NOTES	DECIMAL: X $\pm .030$ .XX $\pm .010$ .XXX $\pm .005$	INTERPRET DIMENSIONS AND TOLERANCES PER ASME Y14.5M - 1994	
SURFACE AREA: N/A	THIRD ANGLE PROJECTION 	DRAWN: JDT 04/05/18 CHECKED: DAL 04/05/18 APPROVED: DAL 04/05/18	SIZE DWG. NO. <b>B</b> SF9321-60086 SCALE: 4:1 SHEET 2 OF 2
PROPRIETARY THE INFORMATION CONTAINED IN THIS DRAWING IS THE SOLE PROPERTY OF SV MICROWAVE, INC. ANY REPRODUCTION IN PART OR AS A WHOLE WITHOUT THE WRITTEN PERMISSION OF SV MICROWAVE, INC IS PROHIBITED.			